



LMD-K 420

Clip-In/Swing-Down cassette ceiling

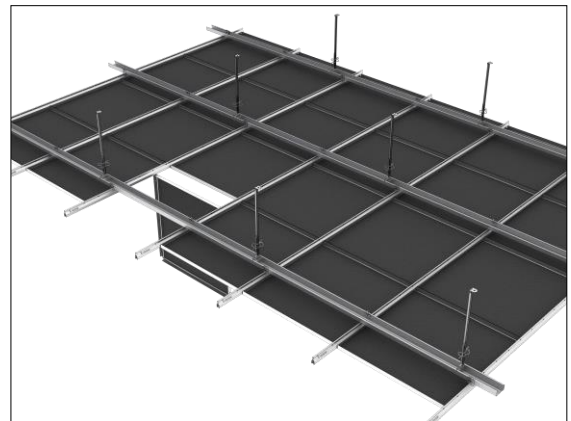
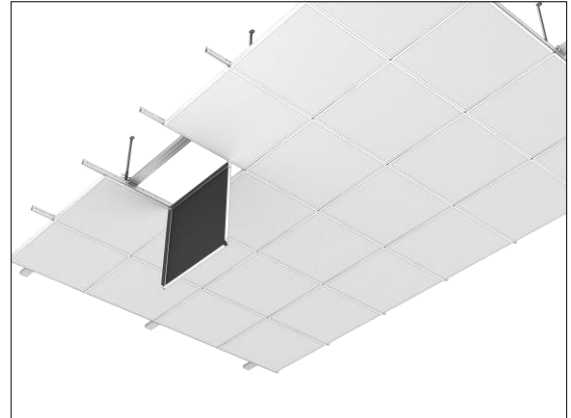

Due to a completely concealed substructure, the system LMD-K 420 has a closed ceiling surface. The uniform joint design structures the view of the ceiling. The maintenance-friendly system provides access to the ceiling void by means of cassettes that can be either removed or separately swung down and slid along the Clip-In profiles.

- homogeneous ceiling surface due to concealed substructure
- maintenance option due to ceiling panels that can be individually operated and swung down
- hygienic and easy to clean



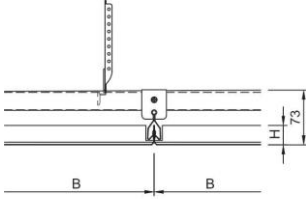

Ceiling elements

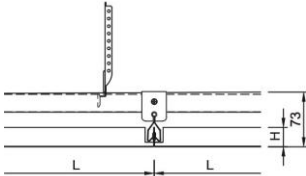
LMD-K 420 Type K3				
Clip-in/Swing-down with L-turn-up and bevel				
Length (L)	600 mm	625 mm		
Width (B)	600 mm	625 mm		
Height (H)	26 mm			
Grid dimension x (Rx)	600 mm	625 mm		
Grid dimension y (Ry)	600 mm	625 mm		
Perforation	without perforation, BASICline Rg 2,5-16, REGULARline Rv 1,8-20			
LMD-K 420 Type K6				
Clip-in/Swing-Down with C-turn-up				
Length (L)	500 - 1,800 mm			
Width (B)	300 - 625 mm			
Height (H)	30 mm			
Grid dimension x (Rx)	500 - 1,800 mm			
Grid dimension y (Ry)	300 - 625 mm			
Perforation	all BASICline and REGULARline standard perforations possible			

Technical data

Material	galvanised sheet steel
Weight	approx. 8 - 10 kg/m ² (without fixtures/installations)
Serviceability	swing-down option or removable
Wall connection options	L-angle, shadow gap trim



Component list

1	ceiling panel
7/8/9	vernier suspension
18	self-tapping screw trapezoidal head
26	suspension channel 60
72	clip-in profile
74	connector for suspension channel 60 to clip-in profile

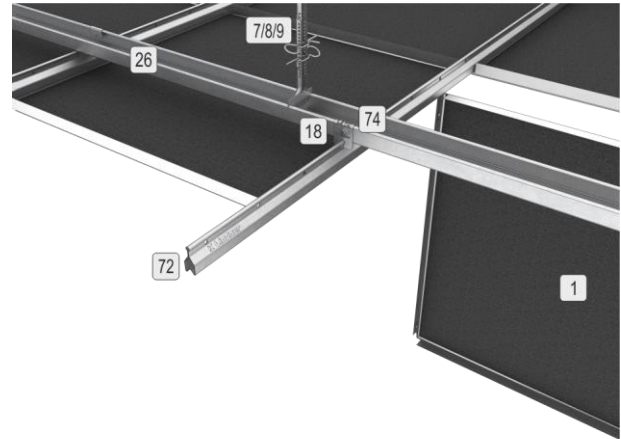

Acoustics

Room acoustics

Rated sound absorption coefficient	DIN EN ISO 11654	α_w	0.15 - 1.00
Sound absorber class	DIN EN ISO 11654		E - A
Noise Reduction Coefficient	ASTM C 423	NRC	0.15 - 0.95

Fire protection

Building material class

Building material class	DIN EN 13501-1	A2 - s1, d0
Building material class	ASTM E 84	Class A

Durability

Exposure class	DIN EN 13964	A
----------------	--------------	---



Sustainability

Product self-declaration	Self-declaration according to ISO 14021
Environmental product declaration	EPD according to EN 15804 / ISO 14025
Circular Economy	Cradle to Cradle Certified® Gold
French VOC Regulation	Emission class A+

Statics

Seismic safety	qualification according to AC 156/Eurocode/SIA 261
----------------	--

Certifications

CE marking	The ceiling system is a harmonised construction product acc. to regulation (EU) No. 305/2011 (Construction Products Regulation) and EN 13964: Suspended ceilings - Requirements and test methods.
TAIM e.V.	The ceiling system fulfils the requirements of the "Technical Manual Metal Ceilings" (TMMC) of TAIM e.V. (Association of Industrial Metal Ceiling Manufacturers).

Surfaces

Powder coatings	<u>COLOURline - Powder coating</u> <u>MOODline - Powder coating, deep matt</u> <u>GRAPHICline - Digital print</u>
Perforation	<u>BASICline - Standard perforations</u> <u>REGULARline - Further perforations</u> <u>SPREADline - Scattered perforations</u>

Additional equipment

Acoustic inlays	<u>Acustica - Acoustic fabric inlay</u> <u>Insula - Mineral wool inlay in acoustic foil</u> <u>Calma - Glass yarn inlay in textile cover</u>
Luminaires	<u>IS 450 - Integrated luminaire for office and general areas</u> <u>FR 625 - Integrated luminaire</u> <u>Q 600 - Integrated luminaire</u>



Application examples



© samba photography

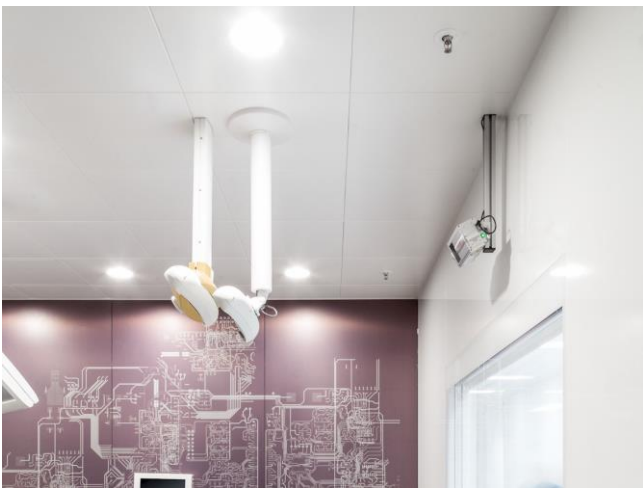

© lemke Ruige M.A.

Project solutions

This product data sheet refers to the standard version of the product mentioned above. We would be happy to work with you to find the right solution for your project. Adapted to your building project, you will receive a perfectly matched system. Project-specific constructions and adaptations can be found in the offer documents.